

TASCAM

TEAC Professional Division

CD-150

Compact Disc Player

COMPACT
disc
DIGITAL AUDIO

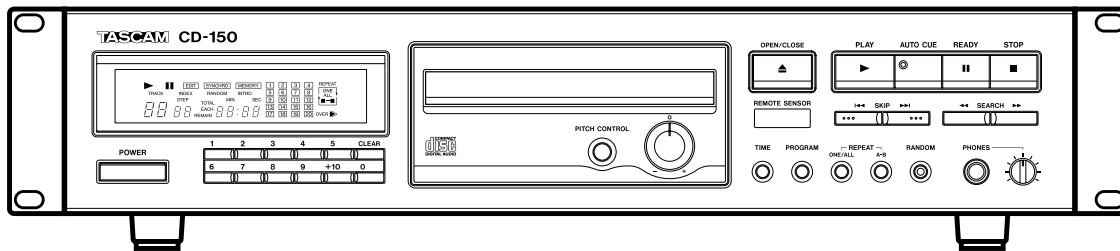

**OWNER'S MANUAL / MANUEL DU PROPRIETAIRE
BEDIENUNGSANLEITUNG / MANUALE DI ISTRUZIONI
MANUAL DEL USUARIO / GEBRUIKSAANWIJZING**



CAUTION
RISK OF ELECTRIC SHOCK
DO NOT OPEN



CAUTION: TO REDUCE THE RISK OF ELECTRIC SHOCK, DO NOT REMOVE COVER (OR BACK). NO USER-SERVICEABLE PARTS INSIDE. REFER SERVICING TO QUALIFIED SERVICE PERSONNEL.



The lightning flash with arrowhead symbol, within an equilateral triangle, is intended to alert the user to the presence of uninsulated "dangerous voltage" within the product's enclosure that may be of sufficient magnitude to constitute a risk of electric shock to persons.



The exclamation point within an equilateral triangle is intended to alert the user to the presence of important operating and maintenance (servicing) instructions in the literature accompanying the appliance.

This appliance has a serial number located on the rear panel. Please record the model number and serial number and retain them for your records.
Model number _____
Serial number _____

WARNING: TO PREVENT FIRE OR SHOCK HAZARD, DO NOT EXPOSE THIS APPLIANCE TO RAIN OR MOISTURE.

ENGLISH

FRANÇAIS

DEUTSCH

ITALIANO

ESPAÑOL

NEDERLANDS

IMPORTANT SAFETY INSTRUCTIONS

CAUTION:

- Read all of these Instructions.
- Save these Instructions for later use.
- Follow all Warnings and Instructions marked on the audio equipment.

- 1) **Read Instructions** — All the safety and operating instructions should be read before the product is operated.
- 2) **Retain Instructions** — The safety and operating instructions should be retained for future reference.
- 3) **Heed Warnings** — All warnings on the product and in the operating instructions should be adhered to.
- 4) **Follow Instructions** — All operating and use instructions should be followed.
- 5) **Cleaning** — Unplug this product from the wall outlet before cleaning. Do not use liquid cleaners or aerosol cleaners. Use a damp cloth for cleaning.
- 6) **Attachments** — Do not use attachments not recommended by the product manufacturer as they may cause hazards.
- 7) **Water and Moisture** — Do not use this product near water – for example, near a bath tub, wash bowl, kitchen sink, or laundry tub; in a wet basement; or near a swimming pool; and the like.
- 8) **Accessories** — Do not place this product on an unstable cart, stand, tripod, bracket, or table. The product may fall, causing serious injury to a child or adult, and serious damage to the product. Use only with a cart, stand, tripod, bracket, or table recommended by the manufacturer, or sold with the product. Any mounting of the product should follow the manufacturer's instructions, and should use a mounting accessory recommended by the manufacturer.
- 9) A product and cart combination should be moved with care. Quick stops, excessive force, and uneven surfaces may cause the product and cart combination to overturn.



10) Ventilation — Slots and openings in the cabinet are provided for ventilation and to ensure reliable operation of the product and to protect it from overheating, and these openings must not be blocked or covered. The openings should never be blocked by placing the product on a bed, sofa, rug, or other similar surface. This product should not be placed in a built-in installation such as a bookcase or rack unless proper ventilation is provided or the manufacturer's instructions have been adhered to.

— This product should be operated only from the type of power source indicated on the marking label. If you are not sure of the type of power supply to your home, consult your product dealer or local power company. For products intended to operate from battery power, or other sources, refer to the operating instructions.

12) Grounding or Polarization — This product may be equipped with a polarized alternating-current line plug (a plug having one blade wider than the other). This plug will fit into the power outlet only one way. This is a safety feature. If you are unable to insert the plug fully into the outlet, try reversing the plug. If the plug should still fail to fit, contact your electrician to replace your obsolete outlet. Do not defeat the safety purpose of the polarized plug.

13) Power-Cord Protection — Power-supply cords should be routed so that they are not likely to be walked on or pinched by items placed upon or against them, paying particular attention to cords at plugs, convenience receptacles, and the point where they exit from the product.

14) Outdoor Antenna Grounding — If an outside antenna or cable system is connected to the product, be sure the antenna or cable system is grounded so as to provide some protection against voltage surges and built-up static charges. Article 810 of the National Electrical Code, ANSI/NFPA 70, provides information with regard to proper grounding of the mast and supporting structure, grounding of the lead-in wire to an antenna discharge unit, size of grounding conductors, location of antenna-discharge unit, connection to grounding electrodes, and requirements for the grounding electrode.

"Note to CATV system installer:

This reminder is provided to call the CATV system installer's attention to Section 820-40 of the NEC which provides guidelines for proper grounding and, in particular, specifies that the cable ground shall be connected to the grounding system of the building, as close to the point of cable entry as practical."

Example of Antenna Grounding as per National Electrical Code, ANSI/NFPA 70

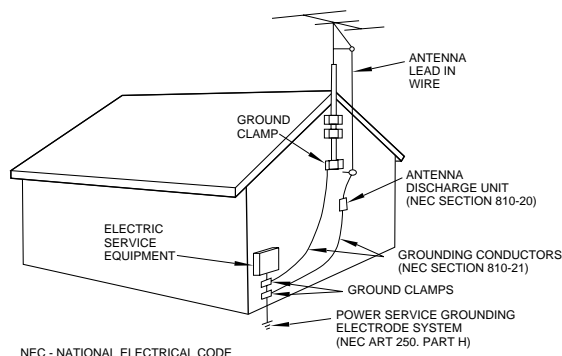

15) Lightning — For added protection for this product during a lightning storm, or when it is left unattended and unused for long periods of time, unplug it from the wall outlet and disconnect the antenna or cable system. This will prevent damage to the product due to lightning and power-line surges.

16) Power Lines — An outside antenna system should not be located in the vicinity of overhead power lines or other electric light or power circuits, or where it can fall into such power lines or circuits. When installing an outside antenna system, extreme care should be taken to keep from touching such power lines or circuits as contact with them might be fatal.

17) Overloading — Do not overload wall outlets, extension cords, or integral convenience receptacles as this can result in risk of fire or electric shock.

18) Object and Liquid Entry — Never push objects of any kind into this product through openings as they may touch dangerous voltage points or short-out parts that could result in a fire or electric shock. Never spill liquid of any kind on the product.

19) Servicing — Do not attempt to service this product yourself as opening or removing covers may expose you to dangerous voltage or other hazards. Refer all servicing to qualified service personnel.

20) Damage Requiring Service — Unplug this product from the wall outlet and refer servicing to qualified service personnel under the following conditions:

- a) when the power-supply cord or plug is damaged.
- b) if liquid has been spilled, or objects have fallen into the product.
- c) if the product has been exposed to rain or water.
- d) if the product does not operate normally by following the operating instructions. Adjust only those controls that are covered by the operating instructions as an improper adjustment of other controls may result in damage and will often require extensive work by a qualified technician to restore the product to its normal operation.
- e) if the product has been dropped or damaged in any way.
- f) when the product exhibits a distinct change in performance – this indicates a need for service.

21) Replacement Parts — When replacement parts are required, be sure the service technician has used replacement parts specified by the manufacturer or have the same characteristics as the original part. Unauthorized substitutions may result in fire, electric shock, or other hazards.

22) Safety Check — Upon completion of any service or repairs to this product, ask the service technician to perform safety checks to determine that the product is in proper operating condition.

23) Wall or Ceiling Mounting — The product should be mounted to a wall or ceiling only as recommended by the manufacturer.

24) Heat — The product should be situated away from heat sources such as radiators, heat registers, stoves, or other products (including amplifiers) that produce heat.

SAFETY INFORMATION

This product has been designed and manufactured according to FDA regulations "title 21, CFR, chapter 1, subchapter J, based on the Radiation Control for Health and Safety Act of 1968", and is classified as a class 1 laser product. There is no hazardous invisible laser radiation during operation because invisible laser radiation emitted inside of this product is completely confined in the protective housings.

The label required in this regulation is shown ①.

● CAUTION

- DO NOT REMOVE THE PROTECTIVE HOUSING USING A SCREWDRIVER.
- USE OF CONTROLS OR ADJUSTMENTS OR PERFORMANCE OF PROCEDURES OTHER THAN THOSE SPECIFIED HEREIN MAY RESULT IN HAZARDOUS RADIATION EXPOSURE.
- IF THIS PRODUCT DEVELOPS TROUBLE, CONTACT YOUR NEAREST QUALIFIED SERVICE PERSONNEL, AND DO NOT USE THE PRODUCT IN ITS DAMAGED STATE.

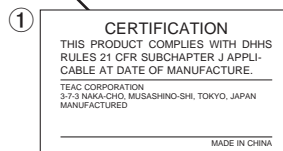
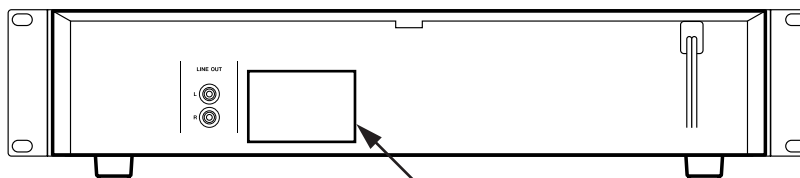

For U.S.A.

Optical pickup: Type : SF-P101
 Manufacturer : SANYO Electric CO., Ltd.
 Laser output : Less than 0.7 mW on the objective lens
 Wavelength : 765-815nm

●CAUTION ●ACHTUNG ●OBSERVERA ●ADVARSEL

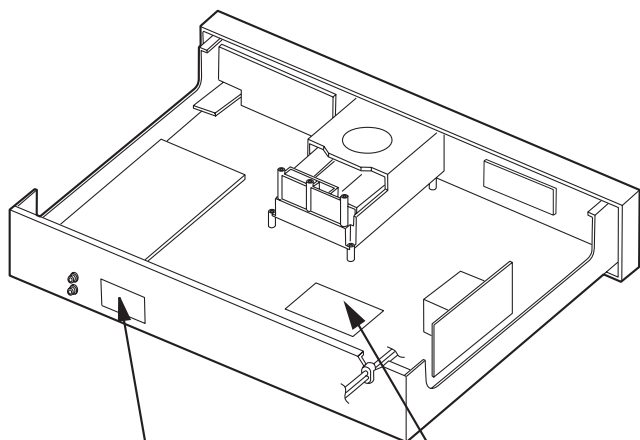

CLASS 1 LASER PRODUCT
LUOKAN 1 LASERLAITE
KLASS 1 LASERAPPARAT

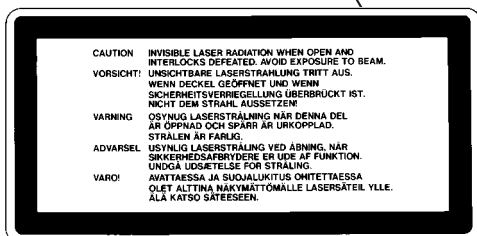

① THIS LABEL IS ATTACHED TO THE PLACE AS ILLUSTRATED TO INFORM THAT THE APPARATUS CONTAINS A LASER COMPONENT.

① DIESE AUFKLEBEMARKE IST AN DEM IN DER ABBILDUNG GEZEIGTEN ORT ANGEBRACHT UM DARAUF HINZUWEISEN, DASS IM INNERN DES GERÄTS EINE LASER-KOMPONENTE BEFINDET.

① PÅSKRIFTEN SITTER PÅ APPARATEN SOM VISAS SOM UPPMANING OM ATT APPARATEN OMFATTAR EN INBYGGD LASERKOMPONENT.

① DETTE MÆRKAT ER ANBRAGT SOM VIST I ILLUSTRATIONEN FOR AT ADVARE BRUGEREN OM AT APPARATET INDEHOLDER EN LASERKOMPONENT.

② DETTE MÆRKAT ER SOM VIST PÅ ILLUSTRATIONEN ANBRAGT PÅ INDERSIDEN AF TOPDÆKSELET FOR AT ADVARE BRUGEREN OM AT YDERLIGERE FREMTRÆNGEN VIL VÆRE FORBUNDET MED FARE FOR AT UDSÆTTE SIG FOR LASERSTRÅLING.

ADVARSEL — BETJENING AF ANDRE KONTROLLER OG REGULATORER ELLER BENYTTES AF ANDRE FREMGANGSMÅDER END BESKREVET HERI ER FORBUNDET MED FARE FOR UDSÆTTELSE FOR LASERSTRÅLING.

VARNING: APPARATEN INNEHÅLLER LASER LOMONENT MED STRÅLNING ÖVERSTIGANDE KLASS 1.

"ADVARSEL: USYNLIG LASERSTRÅLING VED ÅBNING NAR SIKKERHEDSAFBRYDERE ER UDE AF FUNKTION. UNDGÅ UDSÆTTELSE FOR STRÅLING"

"VAROITUS! SUOJAKOTELOA EI SAA AVATA. LAITE SISÄLTÄÄ LASERDIODIN, JOKA LÄHETTÄ (NÄKYMÄTÖNTÄ) SILMILLE VAARALLISTA LASERSÄTEILYÄ".

ADVARSEL: USYNLIG LASERBESTRÅLING NÄR DENNE DELEN ER ÅPEN OG SIKKERHETSSPERREN ER UTKOBLET UNNGÅ UTSETTELSE FOR STRÅLING.

Before Use

Read This Before Operating

- Choose the installation location of your unit carefully. Avoid placing it in direct sunlight or close to a source of heat. Also avoid locations subject to vibrations and excessive dust, heat, cold or moisture. Keep away from such sources that hum, such as transformers or motors.
- Do not open the cabinet as this might result in damage to the circuitry or electrical shock. If a foreign object should get into the set, contact your dealer.
- Be sure not to handle discs with dirty fingers. Never insert a disc which has a crack on the surface.
- When removing the power plug from the wall outlet, always pull directly on the plug, never yank the cord.
- To keep the laser-pickup clean, do not touch it, and do not forget to close the disc tray.
- Do not attempt to clean the unit with chemical solvents as this might damage the finish. Use a clean, dry cloth.
- Keep this manual in a safe place for future reference.

Beware of condensation

When the player (or a compact disc) is moved from a cold to a warm place or used after a sudden temperature change, there is the danger of condensation. Water vapor in the air could condense on the mechanism or the laser pickup. If droplets of water form on these parts, correct playback will be impossible because the laser cannot read the information from the disc correctly. To prevent this, if you are going to use the player in a condition where condensation could occur, you should leave the player for 1 or 2 hours after plugging it into an AC outlet depending on the amount of condensation. If this is done, the player will stabilize at the temperature of its surroundings.

Handling the Discs

This unit has been designed specifically for reproduction of compact discs bearing the "CD" mark. No other discs can be reproduced.

- Always place the compact disc in the disc tray with the label facing upward. (Compact discs can be played only on one side.)
- To remove a disc from its storage case, press down on the center of the case and lift the disc out, holding it carefully by the edges.

How to remove the disc

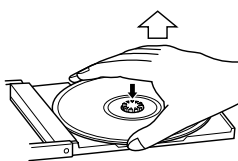

How to hold the disc



- Fingermarks and dust should be carefully wiped off the disc's recorded surface with a soft cloth.

Wipe radially

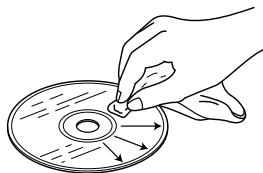

- Never use such chemicals as record sprays, antistatic sprays or fluid, benzene or thinner to clean compact discs. Such chemicals will do irreparable damage to the disc's plastic surface.
- Discs should be returned to their cases after use to avoid serious scratches that could cause the laser pickup to "skip."
- Do not expose discs to direct sunlight or high humidity and temperature for extended periods. Long exposure to high temperatures can warp the disc.
- Do not stick paper or write anything with a ballpoint pen on the surface of the label side.

IMPORTANT (for U.K. Customers)

DO NOT cut off the mains plug from this equipment. If the plug fitted is not suitable for the power points in your home or the cable is too short to reach a power point, then obtain an appropriate safety approved extension lead or consult your dealer.

If nonetheless the mains plug is cut off, remove the fuse and dispose of the plug immediately, to avoid a possible shock hazard by inadvertent connection to the mains supply.

If this product is not provided with a mains plug, or one has to be fitted, then follow the instructions given below:

IMPORTANT. DO NOT make any connection to the larger terminal which is marked with the letter E or by the safety earth symbol \perp or coloured GREEN or GREEN-and-YELLOW.

The wires in the mains lead on this product are coloured in accordance with the following code:

BLUE: NEUTRAL
BROWN: LIVE

As these colours may not correspond with the coloured markings identifying the terminals in your plug proceed as follows:

The wire which is coloured BLUE must be connected to the terminal which is marked with the letter N or coloured BLACK.

The wire which is coloured BROWN must be connected to the terminal which is marked with the letter L or coloured RED.

When replacing the fuse only a correctly rated approved type should be used and be sure to re-fit the fuse cover.

IF IN DOUBT — CONSULT A COMPETENT ELECTRICIAN.

Connections

Before making connections, be sure to read the instruction manual of the stereo amplifier carefully and turn the power of the stereo amplifier and the player OFF.

Caution:

If the CD player interferes with the tuner, TV receiver, etc., allow a reasonable distance between them.

■ Connection with a stereo amplifier

LINE OUT terminals

- Connect the LINE OUT terminals to the CD or AUX terminals of the stereo amplifier using an RCA pin plug cord.
- Make sure to match the color-coded plugs to the appropriate jacks on the components — white to white (L), and red to red (R).
- Be sure to insert each plug securely.

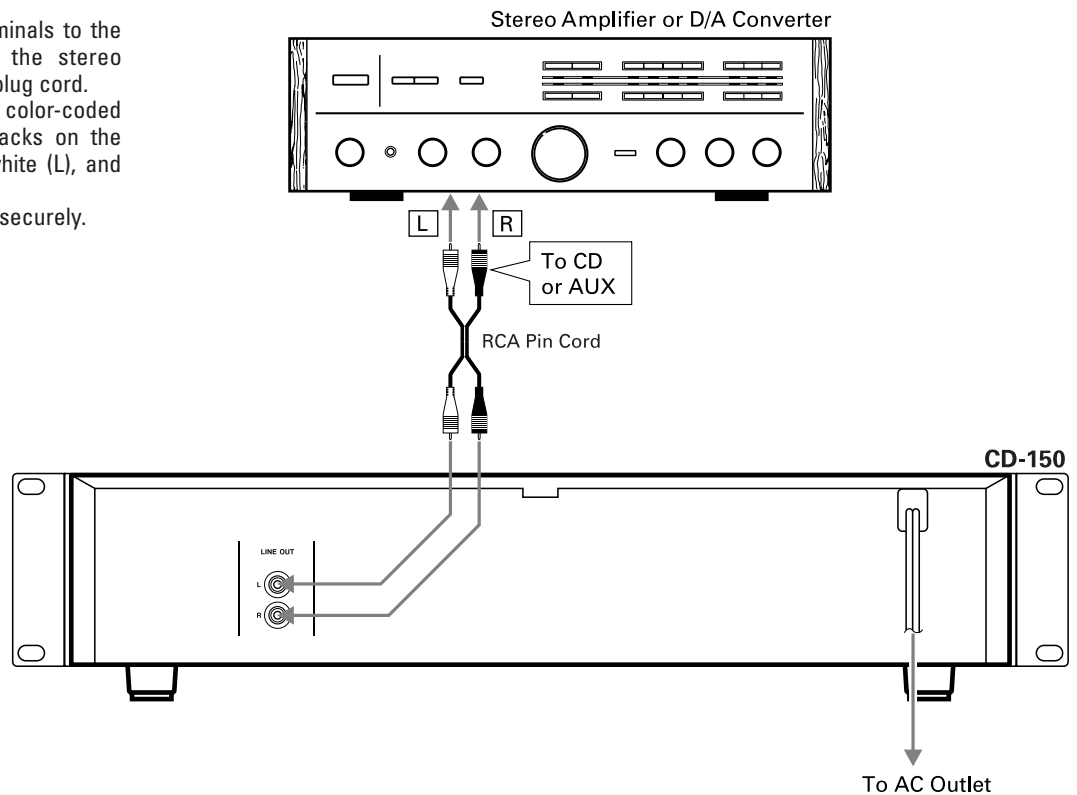

■ Headphones

When using headphones, connect the headphone plug into the PHONES jack.

- Adjust the level of the signals output from the phones jack.

■ Power cord

Be sure to connect the power cord to an AC outlet which supplies the correct voltage.

- Hold the power plug when plugging or unplugging the power cord.

Rack Mounting

Install this deck with the provided mounting screw kit as illustrated.

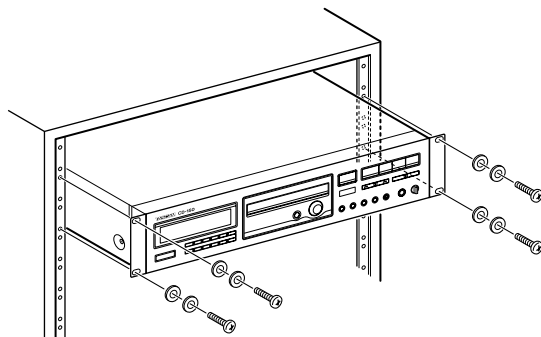

Name of Each Control

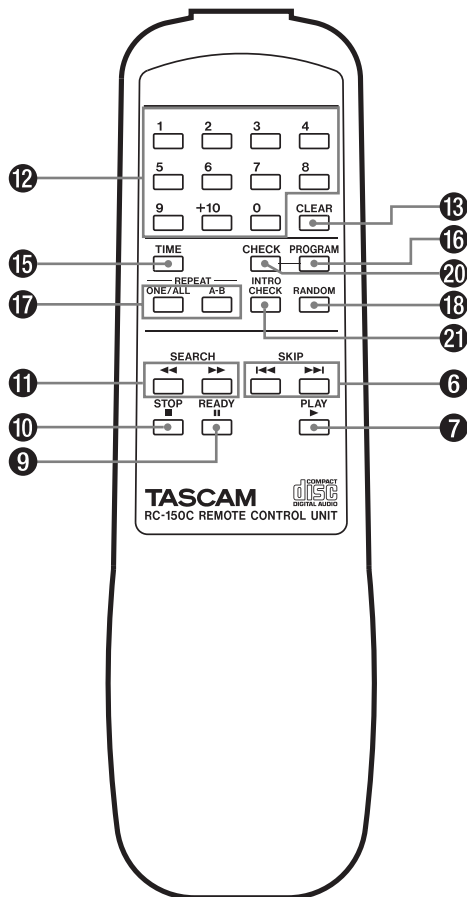
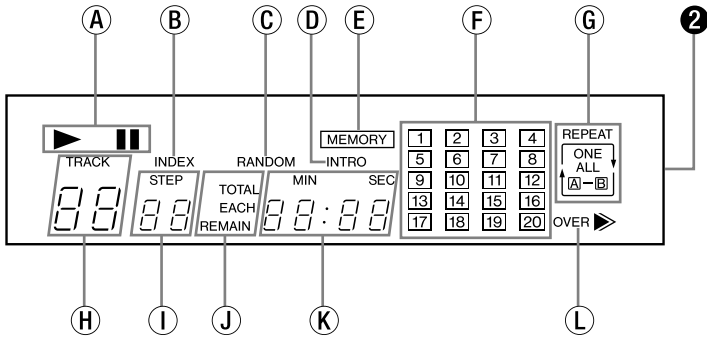
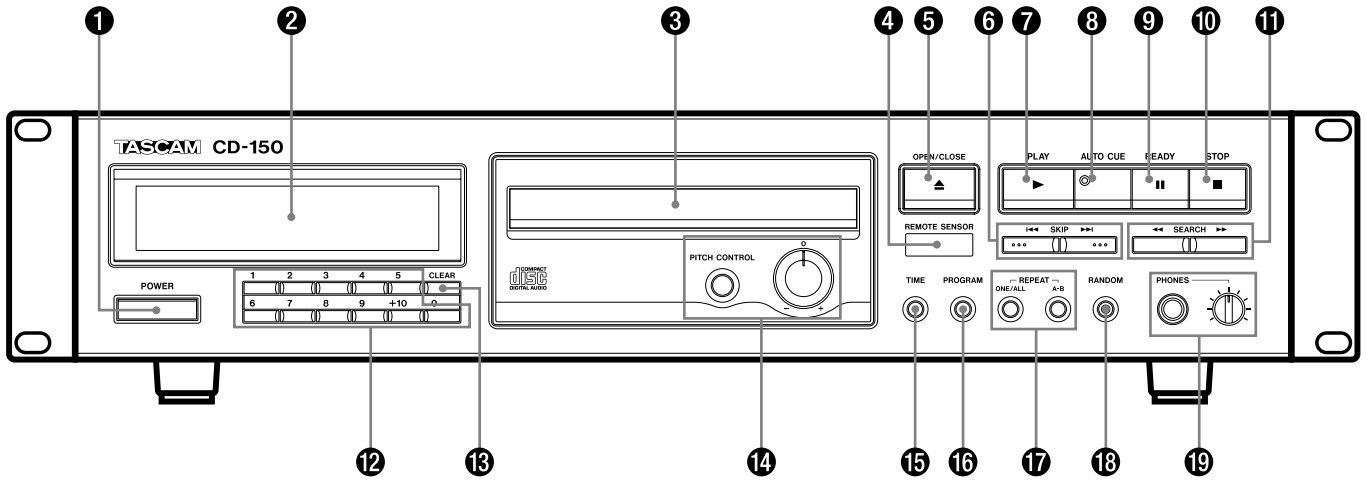

- 1 POWER switch
- 2 Multi-function display window
 - A ► (play) / || (ready) indicators
 - B INDEX indicator
 - C RANDOM indicator
 - D INTRO Check indicator
 - E MEMORY indicator
 - F Music Calendar display
 - G REPEAT (ONE/ALL/A-B) indicators
 - H TRACK indicator
 - I STEP indicator
 - J TOTAL/EACH/REMAIN time indicators
 - K Time counter
 - L OVER indicator
- 3 Disc tray
- 4 REMOTE SENSOR
- 5 OPEN/CLOSE button (▲)
- 6 SKIP buttons (◀◀ / ▶▶)
- 7 PLAY button (▶)
- 8 AUTO CUE button (◎)
- 9 READY button (||)
- 10 STOP button (■)
- 11 SEARCH buttons (◀◀ / ▶▶)
- 12 Numeric buttons (1-9, +10, 0)
- 13 CLEAR button
- 14 PITCH CONTROL on/off button / PITCH CONTROL knob
- 15 TIME button
- 16 PROGRAM button
- 17 REPEAT (ONE/ALL, A-B) buttons
- 18 RANDOM play button
- 19 PHONES level control / PHONES jack
- 20 CHECK button
- 21 INTRO CHECK button

Operations

Basic Operation

1. Press the POWER switch.

- The indicator blinks in the display.
- When no disc is inserted, "no dISC" lights.
- Be sure to turn the volume of the amplifier down to protect the speakers from damage.

2. Press the OPEN/CLOSE (▲) button.

The disc tray will slide out and "OPEN" will be indicated in the display. Place the disc gently on the tray with its label side facing upward. The disc is set within the disc guides at the center of the tray.

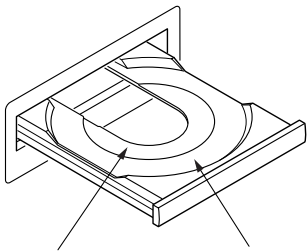

For 8 cm (3-inch)
CD singles

For 12 cm (5-inch)
Compact Discs

3. Press the OPEN/CLOSE (▲) button again.

The disc tray will close. Several seconds later, the following information is displayed and the player enters the standby mode.

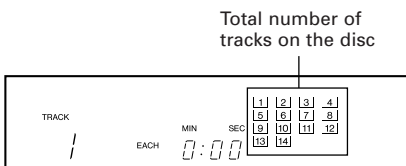

- The Music Calendar then lights, displaying track numbers up to 20.
- 4. **Press the PLAY (▶) button.**
Disc playback starts from the first track, and the ▶ (play) indicator will light.
- If the total track number exceeds 20 (OVER blinks), the track number should be confirmed on the TRACK display.
- During playback, the number of the currently played track blinks on the Music Calendar.
- When tracks have been played, their numbers will disappear from the Music Calendar display.

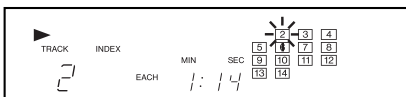

5. To check the playing time: Press the TIME button.

- Press the TIME button in the stop mode to display the total disc playback time and the total number of tracks on the disc.
- Press the TIME button during playback to display the each remaining time of the track being played.
Displayed when the TIME button is pressed twice. The time displayed is the total remaining playback time from the position being played, to the end of the disc.

6. To temporarily suspend playback (ready mode): Press the II button.

Playback stops at the current position and the II indicator blinks. To resume playback from the same position, press the ▶ or II button.

7. To stop playback:

Press the STOP (■) button.
The player enters the stop mode.

8. To unload the disc:

Press the OPEN/CLOSE (▲) button.
Playback stops and the disc tray will slide out, and all functions are reset to their initial settings.

■ Even if the disc tray is open....

When the ▶ button is pressed:

The disc tray will close and playback starts from the first track.

Direct access play:

Press the numeric buttons corresponding to the required track. The player starts from the specified track directly.

Example 1:

To play the 5th track:

Press .

Example 2:

To play the 21st track:

Press → → .

CAUTION:

- Do not force the tray by hand during opening and closing operations.
- Do not leave the disc tray open when the player is not in use to prevent dirt and dust from entering the mechanism.

Random Playback

- This function is possible only when the player is in the stop mode.

1. Press the RANDOM button.

The RANDOM indicator lights in the display.

2. The indication rotates on the TRACK display while the player is shuffling the tracks.

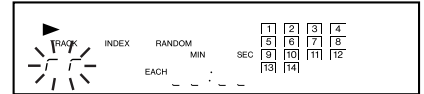

3. Tracks will be randomly selected and played back.

- Press the button with random play function engaged to select a track at random. Press the button to replay currently played track from its beginning.
- A track cannot be replayed after it has been played in this mode.
- To release the random play function while it is engaged, press the STOP (■) button, then press the RANDOM button.

Auto Cue

1. Press the AUTO CUE (⊙) button in the stop mode.

The AUTO CUE indicator will light, and AUTO CUE function is activated.

2. To cue to the first track on the disc, press the PLAY (▶) button.

The player will automatically search the beginning of the first track, and enters the ready mode.

3. Press the PLAY (▶) button again to begin playback.

4. To select a track other than the first track, enter the desired track number using the numeric buttons on the unit or the remote control.

The player will automatically search to the beginning of the track selected, and enter the ready mode.

5. Press the PLAY (▶) button to begin playback of the selected track.

6. When the SKIP button (◀◀/▶▶) is pressed while the AUTO CUE function is activated, the player will skip to the beginning of the new desired track and enter the ready mode.

7. Press the PLAY (▶) button to begin playback of the new desired track.

Pitch Control

Press the PITCH CONTROL button in the stop mode.

- Changing pitch rapidly during playback may cause noise problems.
- The PITCH CONTROL button is operational only in the stop mode.

1. Press the **PITCH CONTROL** button.
The PITCH CONTROL button lights.
2. Turn the **PITCH CONTROL** knob right or left to change pitch.
3. Turning right makes playback speed faster within the range 0 ~ +6%.
4. Turning left makes playback speed slower within the range 0 ~ -6%.

Intro Check Function

The Intro Check function allows only the beginning of each track to be played for 10 seconds.

- This function is operational both at stop and during normal playback.

1. Press the **INTRO CHECK** button.
 2. Press the **PLAY (▶)** button.
The INTRO indicator lights in the display.
 3. Press the **INTRO CHECK** button again to clear the Intro Check function.
- The Intro Check function also works together with RANDOM and REPEAT ONE/ALL functions. This function will not stop until the STOP (■) button is pressed.
 - The Intro Check function also works together with the PROGRAM function.
 - To release the Intro Check function while it is engaged, press the STOP (■) button twice.

Program Playback

- Programming tracks is possible only when the player is in the stop mode.
- The program playback function allows you to program up to 32 tracks for playback in any desired order.
- If more than 20 tracks are entered, the rest will not be shown on the Music Calendar display.

Programming required tracks

Example:

To program tracks in the order 7 → 4 → 15 → 10 in the stop mode.

1. Press the **STOP (■)** button.
2. Press the **PROGRAM** button.
The player enters the program mode. The MEMORY indicator lights in the display. The TRACK No. and STEP No. indicators blink.

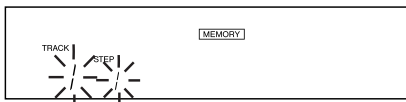

3. Press the numeric buttons in the following order;



They are automatically stored in the program memory in order.

- Press "7" with the numeric buttons on the unit or the remote control. "7" appears in the Music Calendar, TRACK No. "7" and next STEP "2" blink in the display.

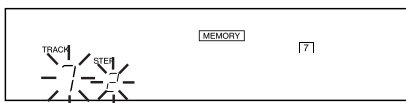

- When "+10" is pressed, "1-" will be lit in the TRACK indication and "3" will blink in the STEP indication. When "5" is pressed, "15" appears in the Music Calendar, TRACK No. "15" and next STEP "4" blinks in the display.
- The same track can be programmed repeatedly.
- To program in the stop mode, select a track using the I◀◀/▶▶I buttons (the track number blinks). Press the PROGRAM button to store it in memory.

4. Press the **PLAY (▶)** button.
Programmed playback starts from the first programmed track.
- Playback stops when the last programmed track has finished playing.
- The programmed contents will be held in memory even after programmed playback has been completed or when programmed playback is stopped by pressing the STOP (■) button.
- To release the program mode, press the PROGRAM button in the stop mode.

Checking the programmed contents

The programmed contents can be checked easily using the CHECK button.

1. Press the **STOP (■)** button.
2. Press the **CHECK** button.
Each time the CHECK button is pressed, the TRACK number and STEP number appear in the programmed order.

Clearing the program memory

1. Press the **STOP (■)** button.
2. Press the **CLEAR** button (more than 2 seconds) to clear the program memory.

- Press the OPEN/CLOSE (▲) button once, and the program memory will be cleared.
- The program memory will also be cleared if the CD player's power is switched off.

Changing the program

After programming is complete, unnecessary tracks can be deleted from the original program or new tracks can be added after a track originally programmed, in the following way.

Renewing a track

1. Press the **STOP (■)** button, then press the **CHECK** button to indicate the desired STEP number in the display.
2. To modify the program, input the desired TRACK No. using the numeric buttons. The indicated track which was previously programmed is modified.

Adding a track

1. Press the **STOP (■)** button.
 2. Press the **CHECK** button until the last step is shown in the display.
 3. To add new tracks to a program, input the track number using the numeric buttons.
- The track is added after the indicated track which was previously programmed.

Deleting a specific track

1. Press the **STOP (■)** button, then press the **CHECK** button to indicate the desired STEP number in the display.
 2. Press the **CLEAR** button.
- The track number displayed will be deleted and the next track advances up.
 - Repeat the same steps to delete other track numbers.

Repeat Function

All or one of the tracks, or a specified portion (between A - B) of a track can be played repeatedly. Program playback and Random playback can also be repeated.

- To repeat random playback, press the REPEAT ONE/ALL and RANDOM buttons (REPEAT/ALL and RANDOM light). Random playback of all tracks is repeated.
- To repeat program playback, press the REPEAT ONE/ALL and PROGRAM buttons (MEMORY and REPEAT/ALL

light). All programmed tracks are played back repeatedly.

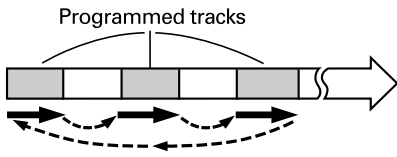

- To cancel Repeat playback and continue normal playback from the current track, press the ONE/ALL button repeatedly until the REPEAT indicator disappears.
- Press the STOP (■) button to abort the operation.

■ To repeat an entire disc (All repeat mode)

1. **Press the ONE/ALL button.**
The REPEAT and ALL indicators light.
2. **Press the PLAY (▶) button.**
Playback starts and, when the end of the disc is reached, the player will return to the beginning of the first track, and then playback continues repeatedly.

■ To repeat one track (Single repeat mode)

1. **Press the ONE/ALL button twice.**
The REPEAT and ONE indicators light.
 2. **Press the numeric buttons corresponding to the required track.**
The selected track is played, then when the end of the track is reached, the player will return to the beginning of the track and playback starts again. In this way, the selected track will be played back repeatedly.
- This function does not work together with Random function.

■ To repeat a designated section (A-B repeat mode)

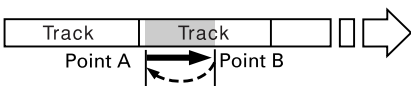

1. **Press the PLAY (▶) button to start playback.**
2. **Designate the point at which playback should start (point A) by pressing the A-B button.**
The REPEAT and A – indicators light.

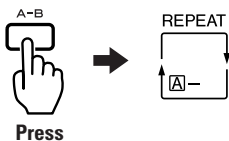

3. Press the A-B button again (REPEAT and A-B light.) at the ending point (B).

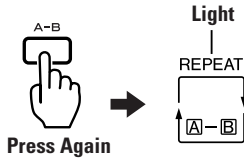

- The portion (A-B) will be played repeatedly.
- To cancel Repeat playback and resume normal playback, press the A-B button.
- When you specify an A-B section during programmed playback, pressing the ◀◀/▶▶ buttons to change the track erases the A-B section.
- This function does not work together with Intro Check and Random functions.

Music Search Operation

■ Music search using SKIP buttons (◀◀/▶▶)

The beginning of any track can be easily located using the ◀◀ and ▶▶ SKIP buttons during playback or in the ready mode. This operation is indicated clearly in the TRACK display.

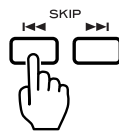

■ To skip to the next track Press the ▶▶ button.

The player will skip ahead to the next track each time the ▶▶ button is pressed. The player can be advanced to the last track in this way, but once the beginning of the last track is reached, the player will not advance even if the ▶▶ button is pressed.

■ To skip back to the previous track Press the ◀◀ button.

The player will skip back one track each time the ◀◀ button is pressed. If this button is pressed in the middle of a track, the player will skip back to the beginning of the current track. To make it skip back to the previous track, the button must be pressed twice.

In this way, the player can be returned to the beginning of the first track on the disc.

■ Music search using SEARCH buttons (◀◀/▶▶)

During playback, hold down the ▶▶ button to move the playing position quickly in the forward direction, and hold down the ◀◀ button to move quickly in the reverse direction.

During the manual search operation, sound will be audible but the output level will be lowered. This lets you search for any required portion while checking the sound.

When the desired position is reached, release the button to reenter the previous mode.

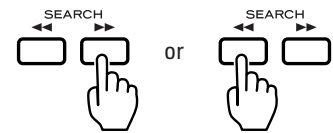

Time Counter Display

The time counter shows various time readouts, as follows.



Stop mode during normal playback:

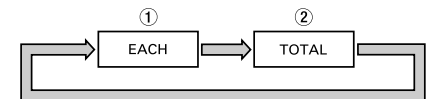

① EACH indicator

After the disc tray is closed with the disc loaded, the EACH indicator lights in the display and the player enters the standby mode.

② Total disc playback time (TOTAL)

Press the TIME button in the stop mode to display the total disc playback time and the total number of tracks on the disc.

During normal playback:

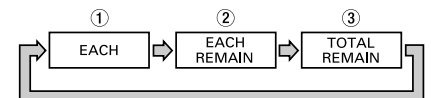

① Elapsed time display (EACH)

The elapsed time of the track being played is then displayed in minutes and seconds.

Remote-Controlled Operation

② Remaining time display (EACH REMAIN)

Press the TIME button to light EACH REMAIN up.

This provides an easy check of the total remaining time of the track being played.

③ Total remaining time display (TOTAL REMAIN)

Press the TIME button to light TOTAL REMAIN up.

This provides an easy check of the total remaining time required to finish the disc.

- Displayed after the TIME button is pressed three times. The time displayed is the elapsed playback time.
- The TOTAL REMAIN time may not appear in the display during program playback or random playback, and the time counter will not be displayed while in the stop mode during program playback, even when the TIME button is pressed.

■ Remote Control Unit

The provided Remote Control Unit allows the unit to be operated from a distance.

When operating the remote control unit, point it towards the remote sensor on the front panel of the unit.

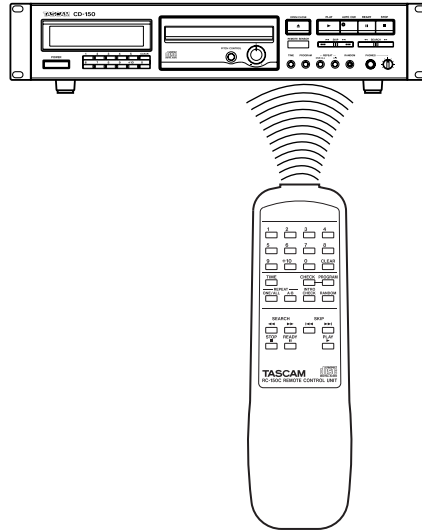

- Even if the remote control unit is operated within the effective range, remote control operation may be impossible if there are any obstacles between the player and the remote control.
- If the remote control unit is operated near other appliances which generate infrared rays, or if other remote control devices using infrared rays are used near the player, the player may operate incorrectly. In the reverse way, the other appliances may operate incorrectly.

■ Battery Installation

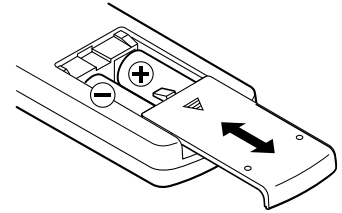

1. Remove the battery compartment cover.
2. Insert two "AA" (R6, SUM-3) dry batteries.

Make sure that the batteries are inserted with their positive ⊕ and negative ⊖ poles positioned correctly.

3. Close the cover until it clicks.

Battery Replacement

If you notice that the distance between the remote control unit and the player for correct operation becomes shorter, it indicates that the batteries are exhausted. In this case replace the batteries with new ones.

Precautions Concerning Batteries

- Be sure to insert the batteries with correct positive ⊕ and negative ⊖ polarities.
- Use batteries of the same type. Never use different types of batteries together.
- Rechargeable and non-rechargeable batteries can be used. Refer to the precautions on their labels.
- When the remote control unit is not to be used for a long time (more than a month), remove the batteries from the remote control unit to prevent them from leaking. If they leak, wipe away the liquid inside the battery compartment and replace the batteries with new ones.
- Do not heat or disassemble batteries and never dispose of old batteries by throwing them in a fire.

Specifications

CD PLAYER

Disc: 8-cm/12-cm CD
Audio Channel: 2 channels
Quantization: 16-bit linear
Sampling Frequency: 44.1 kHz
Analog Output (RCA)
Nominal output level: -10 dBV
 (load impedance 10 kohms, unbalanced)
Maximum output level: +6 dBV (2Vrms)
Output impedance: 2.5 kohms
Headphone Output (standard stereo phone jack): 11 mW at max. (load impedance 32 ohms)
Frequency Response: 20 Hz – 20 kHz \pm 1.5dB
Signal-to-Noise Ratio (S/N): >85 dB (1 kHz)
Total Harmonic Distortion: < 0.02 % (1 kHz)
Channel Separation: >80 dB (1 kHz)
Pitch Control: \pm 6 %
Auto Cue Level: -60 dB

GENERAL

Power Requirements:
 120 VAC, 60 Hz (U.S.A./ Canada Model)
 230 VAC, 50Hz (UK/Europe Model)
 240 VAC, 50Hz (Australia Model)
Power Consumption: 9 Watts (AC)
Dimensions (W x H x D): 482 x 104 x 304 mm
 (19" x 4-1/8" x 11-15/16")
Net Weight: 4.4 kg (9.7 lbs.)

Standard Accessories:

- Wireless Remote Control Unit (RC-150C), Battery (SUM-3, "AA", "R6" type) x 2, Rack Mounting Screw Kit, RCA Pin-plug Cord
- Improvements may result in specification or feature changes without notice.
 - Illustrations may differ slightly from production models.

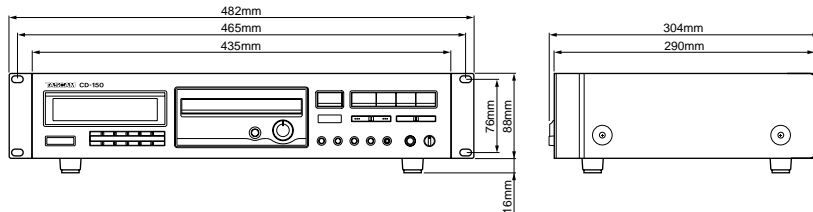

Troubleshooting

Basic troubleshooting of a CD player is similar to troubleshooting of any other electrical or electronic equipment. Always check the most obvious possible causes first. To give you a few ideas of what to look for, check the following:

Problem	Probable Cause	Remedy
No power when POWER is pressed.	Power plug not inserted securely.	Plug in securely.
No playback when disc is loaded.	Disc loaded with label side down.	Load with label side up.
	Disc dirty.	Clean disc surface.
No audio output.	Connection to stereo system is incorrect.	Check connections.
A single track can only be played.	ONE/ALL button engaged.	Press button to disengage it.
No program playback.	PROGRAM button not pressed.	Press button to display "MEMORY".
Mistracing (sound jumping).	Player receiving vibration or shock.	Change the installation position of the player.
	Disc dirty.	Clean disc surface.
Hum.	Pin-cord plug not connected securely.	Re-connect plug securely.
Noise in tuner.	Player too near tuner.	Keep a reasonable distance between them or switch off player's power.
Remote control unit operation is impossible.	Player's POWER switch set to OFF.	Set switch to ON.
	Batteries not inserted in remote control unit.	Insert batteries.

Caution:

Since the unit incorporates a microcomputer, it may not operate correctly because of external noise, etc. If this happens, turn the power switch OFF, then turn it ON again and restart operations.

For U.S.A.

TO THE USER

This equipment has been tested and found to comply with the limits for a Class B digital device, pursuant to Part 15 of the FCC Rules. These limits are designed to provide reasonable protection against interference in a residential area. This device generates and uses radio frequency energy and if not installed and used in accordance with the instructions, it may cause interference to radio or TV reception. If this unit does cause interference with TV or radio reception you can try to correct the interference by one or more of the following measures:

- a) Reorient or relocate the receiving antenna.
 - b) Increase the separation between the equipment and the receiver.
 - c) Plug the equipment into a different outlet so that it is not on the same circuit as the receiver.
- If necessary, consult the dealer or an experienced radio/TV technician for additional suggestions.

CAUTION:

Changes or modifications to this equipment not expressly approved by TEAC CORPORATION for compliance could void the user's authority to operate this equipment.

For CANADA

AC POWER CORD CONNECTION

CAUTION:

TO PREVENT ELECTRIC SHOCK, MATCH WIDE BLADE OF PLUG TO WIDE SLOT, FULLY INSERT.

CORDE DE CONNEXION CA

ATTENTION:

POUR ÉVITER LES CHOCS ÉLECTRIQUES, INTRODUIRE LA LAME LA PLUS LARGE DE LA FICHE DANS LA BORNE CORRESPONDANTE DE LA PRISE ET POUSSER JUSQU'AU FOND.

TEAC CORPORATION

3-7-3, Nakacho, Musashino-shi, Tokyo 180-8550, Japan Phone: (0422) 52-5082

TEAC AMERICA, INC.

7733 Telegraph Road, Montebello, California 90640 Phone: (213) 726-0303

TEAC CANADA LTD.

5939 Wallace Street, Mississauga, Ontario L4Z 1Z8, Canada Phone: 905-890-8008 Facsimile: 905-890-9888

TEAC MEXICO, S.A. De C.V

Privada De Corina, No.18, Colonia Del Carmen Coyoacan, Mexico DF 04100 Phone: 5-658-1943

TEAC UK LIMITED

5 Marlin House, Marlins Meadow, The Croxley Centre, Watford, Herts. WD1 8YA, U.K. Phone: 01923-819699

TEAC DEUTSCHLAND GmbH

Bahnstrasse 12, 65205 Wiesbaden-Erbenheim, Germany Phone: 0611-71580

TEAC FRANCE S. A.

17 Rue Alexis-de-Tocqueville, CE 005 92182 Antony Cedex, France Phone: 01.42.37.01.02

TEAC BELGIUM NV/SA

P.A. TEAC Nederland BV, Perkinsbaan 11a, 3439 ND Nieuwegein, Netherlands Phone: 0031-30-6048115

TEAC NEDERLAND BV

Perkinsbaan 11a, 3439 ND Nieuwegein, Netherlands Phone: 030-6030229

TEAC AUSTRALIA PTY., LTD.
A.C.N. 005 408 462

106 Bay Street, Port Melbourne, Victoria 3207, Australia Phone: (03) 9644-2442

TEAC ITALIANA S.p.A.

Via C. Cantù 11, 20092 Cinisello Balsamo, Milano, Italy Phone: 02-66010500
